











OCS8487B

Built-in compact steam oven

Installation: Built-in
 Main colour: Colour of dark grey brushed stainless steel
 Product dimensions (HxWxD): 45,5 x 59,7 x 54,7 cm
 5 Air Flow™ system, Pure steam system, Oven volume - 50 L, AquaClean, 1 level telescopic fully extendable, Sous-vide, AutoRoast, Defrost, Eco



 5 Air Flow™ system	 Pure steam system	 Oven volume - 50 L	 AquaClean
 1 level telescopic fully extendable	 Sous-vide	 AutoRoast	 Defrost
 Eco			

Construction & Performance

- Maximum oven temperature: 230 °C
- Meat Probe
- MultiSteam 360°

Use & flexibility

- Interior lights (Illumination): Both sides
- Water container: 1,3 l
- Volume net (liter): 50 l
- OpenView
- Fully extendable guides
- Fully extendable telescopic guides on one level with stop function
- 1 Premium grill rack
- 1 Full width steam tray non-perforated
- 1 Full width steam tray perforated
- 1 Shallow tray

Standard accessories

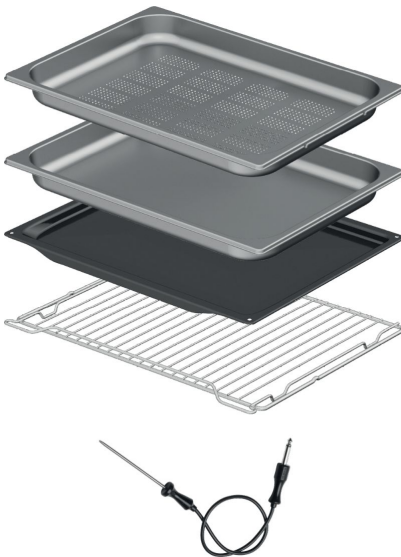

Interaction & Control

- Knob shape: Ergonomic knobs
- TFT display

Programs

- Lower heater BIO
- Upper heater
- Lower and upper heater
- Small infra heater
- Large infra heater
- Large infra heater with ventilaton
- Circular heater
- Eco function
- Lower heater and fan
- Lower heater with fan BIO
- Strong steam
- Medium steam
- Low steam
- Steam baking
- Direct steam injection
- Defrost
- WarmPlate
- StayWarm
- FastPreheat
- STEPBake
- AutoRoast

Design & integration

- Door material: Glass

- Main colour: Colour of dark grey brushed stainless steel
 - TouchFree Inox
 - Adjustable feet: 4
 - Niche dimensions (HxWxD): 45 × 56 × 55 cm
-

Safety & Maintenance

- Dynamic oven cooling plus - DC+
 - SoftOpen and GentleClose door hinge
 - Removable flat oven inner door glass surface
 - AquaClean function
 - Direct steam injection
 - Descaling
-

Technical data

- Energy consumption in standby mode: 1 W
 - Energy class: A+
 - Oven consumption (conventional operation): 0,82 kWh
 - Oven consumption (venting operation): 0,62 kWh
 - Energy consumption conventional: 0,82 kWh
 - Energy consumption forced air: 0,62 kWh
 - Connected load: 2900 W
 - Nominal current: 16 amp
 - Frequency: 50 Hz
-

Dimensions

- Product dimensions (HxWxD): 45,5 × 59,7 × 54,7 cm
 - Length electrical cord: 1,5 m
 - Net weight: 43,5 kg
-

Logistic information

- Dimensions of packed product (HxWxD): 55 × 66 × 70 cm
 - Gross weight: 48,2 kg
 - Product code: 740084
 - EAN code: 3838782577550
-

